

Optical Engineering

SPIDigitalLibrary.org/oe

Two-beam phase-sensitive optical time domain reflectometer based on Jones matrix modeling

Yang An
Xin Feng
Jian Li
Hao Feng
Shijiu Jin

Two-beam phase-sensitive optical time domain reflectometer based on Jones matrix modeling

Yang An
Xin Feng
Jian Li
Hao Feng
Shijiu Jin

Tianjin University
State Key Laboratory of Precision Measurement
Technology & Instruments
Tianjin 300072, China
E-mail: tjupipe@tju.edu.cn

Abstract. A two-beam phase-sensitive optical time domain reflectometer (OTDR) is proposed and experimentally demonstrated. Optical pulses are launched into two distributed fibers. With the interference effect of two channel Rayleigh scattering signals and the positioning principle of the traditional OTDR, detection and location of vibration events along sensing fibers can be achieved using a new signal processing scheme. What is more, to investigate the sensitivity fading problem that often occurred when polarization controller (PC) is not utilized, the optical polarization model based on the equivalent Jones matrices of sensing fibers is established. Simulation results show that due to the polarization characteristic discrepancy of the sensing fibers, the signal amplitude varies a lot for different polarization states of the incident light. Experimental result shows that with the PC, the signal signal to noise ratio can be stabilized as 9.5 dB, which verifies the effectiveness of the sensor. © The Authors. Published by SPIE under a Creative Commons Attribution 3.0 Unported License. Distribution or reproduction of this work in whole or in part requires full attribution of the original publication, including its DOI. [DOI: 10.1117/1.OE.52.9.094102]

Subject terms: fiber optics; distributed fiber sensor; phase-sensitive optical time domain reflectometer; polarization; Jones matrix.

Paper 130597 received Apr. 18, 2013; revised manuscript received Jul. 22, 2013; accepted for publication Aug. 9, 2013; published online Sep. 6, 2013.

1 Introduction

With the features of high sensitivity, large dynamic range, and immunity to electromagnetic interference, distributed fiber sensors have become one of the core technologies to reveal information of various structures and to monitor intrusions.¹ As one of the implements, phase-sensitive optical time domain reflectometer (φ -OTDR) is a research hotspot in recent years.²⁻⁵ In a phase OTDR system, the narrow line-width laser is employed to enhance the interferometric effects for high-phase sensitivity. Therefore, it can respond to phase modulation of the light. By distinguishing the changes in Rayleigh backscattered traces, dynamic events could be monitored.

In prior research, a field test of intruder based on φ -OTDR is demonstrated over 19-km length at the spatial resolution of 100 m using direct detection.⁶ In the literature,⁷ coherent detection is introduced to achieve high signal to noise ratio (SNR), and the broadband acoustic frequency components generated by pencil-break vibration have been measured. Later, the spatial resolution has been improved to 1 m under sensing range of 200 m by using a polarization-maintaining fiber as the sensing fiber.⁸ Besides, wavelet technique has been utilized to reduce the time-domain noise in the φ -OTDR.⁹

However, the aforementioned researches are all based on the one-beam configuration, in which detecting sensitivity is associated with the laser line width.¹⁰ Therefore, we propose a two-beam vibration-sensing system that does not require an ultra-narrow line-width laser, which is necessary in the conventional φ -OTDR. Besides, based on the equivalent Jones matrices of sensing fibers, the cause of polarization-induced fading in the system is investigated by establishing the optical polarization model. Experimental results showed the effectiveness of the sensor. With the employment of the

polarization controller (PC), which is a solution of polarization-induced fading problems according to the analysis, the signal SNR can be stabilized as high as 9.5 dB.

2 Detection Principle and Signal Processing Method

2.1 System Structure and Detection Principle

Figure 1 shows the schematic configuration of the system. The laser source is an ordinary one, which is more economical and easy to attain higher output power, compared with the ultra-narrow line-width light source, which is necessary in the conventional φ -OTDR. Connected with a PC, the continuous wave beam is modulated by an acousto-optic modulator (AOM) to generate a pulsed source. Then, through a circulator, the modulated pulse light is split equally at a coupler and launched into two sensing fibers. When two pulse light beams propagate in the forward direction, the backscattered Rayleigh signals travel in an opposite direction and interfere at the coupler. Through the circulator, again the interference signal is detected by an avalanche photodetector (APD) and processed in an industrial personal computer (IPC) with a data acquisition card (DAQ). The modulation pulse signal is generated by an field-programmable gate array, which is controlled by the IPC through the serial port. Both the pulse frequency and pulse width can be changed by the host computer program to adjust to the sensing range. In order to ensure that the raw trace for every pulse input is acquired, trigger acquisition mode is utilized with the aforementioned pulse signal as the trigger source.

The location principle of the system is actually similar to the conventional φ -OTDR as well as the OTDR. The main difference is that the detection of vibration signals is achieved by the interference effect of two channel

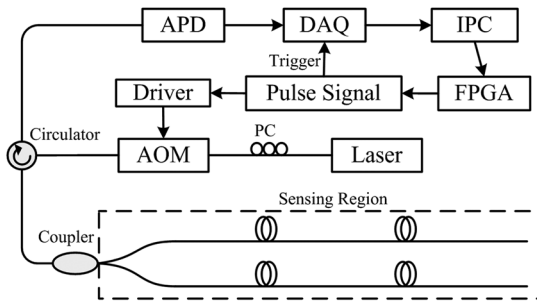

Fig. 1 Schematic configuration of the system. PC: polarization controller; AOM: acousto-optic modulator; APD: avalanche photodetector; DAQ: data acquisition card; IPC: industrial personal computer.

backscattered signals instead of coherent interaction of scattering centers within the pulse duration. Therefore, by measuring any change of interfering optical signals in the backscattered traces, the vibration events along the distributed sensor can be detected. Then by sharpened changes of the interference signal with appropriate signal processing methods, location of the vibration event can be measured using the peak position in the differential trace.

Figure 2 displays one raw backscattered trace acquired by the system. Phase modulation can be observed due to the interference effect of two backscattered signals, whereas the scattering trace acquired by the one-beam configuration under the same experimental condition is just like the conventional OTDR.

2.2 Signal Processing Method

In order to reduce the amplitude fluctuation in raw Rayleigh backscattered traces due to phase noise of the laser and electrical noises such as thermal and shot noises, averaging method has been used in the conventional OTDR and phase OTDR. The commonly used methods are separating averaging method and moving averaging method.⁷ However, due to the time lag between averaged traces obtained with separating averaging method, low-frequency noises may not be filtered out, and thus, cause spurious peaks in the differential trace. On the other side, moving averaging method can eliminate those low-frequency noises but is still unable to achieve high SNR; as the adjacent traces in set are very close, we

could not figure out the vibration signal using the adjacent moving differential method. Besides, the computation of moving averaging method is so huge that it is inapplicable to those fields that require good real-time performance.

To solve this problem, we introduce a step size n to the moving averaging method. Suppose that there are M raw traces set $t = \{t_1, t_2, \dots, t_i, \dots, t_M\}$, where t_i means the i 'th raw trace. Here, raw trace means the trace was directly acquired by using DAQ card for every input pulse. If averaging number is N , then averaged traces set is $T = \{T_1, T_2, \dots, T_i, \dots, T_K\}$, where $K = \text{int}[(M - N)/n] + 1$, and

$$T_i = \frac{1}{N} \sum_{j=ni-n+1}^{ni-n+N} t_j, \quad i \in \{1, \text{int}[(M - N)/n] + 1\}. \quad (1)$$

In order to highlight the changes in averaged traces, we propose a new differential method. Instead of several differential traces,⁸ only one is obtained with all the averaged traces according to the following equation:

$$\Delta T = \sum_{i=1}^{\text{int}[(M-N)/n]} |T_{i+1} - T_i|. \quad (2)$$

Figure 3 displays the superimposed averaged traces as well as the differential trace obtained by Eqs. (1) and (2), respectively. The length of sensing fibers in the experiment is ~ 5 km. The pulse frequency is set to 16 kHz so as to avoid superimposing effect between adjacent raw traces, and the pulse width is set as 200 ns for smaller one, which does not have enough optical power to cover the full length of fiber. A 50-cm length fiber segment is glued to a tabletop, while tapping on the tabletop is used to simulate the vibration event. Through the measurement of a conventional OTDR, the fiber segment is ~ 2.6 km away from the head end of the sensing fiber. The step size n and the averaging number N in the averaging algorithm are set to 10 and 100, respectively. From Fig. 3(c), we can obviously distinguish the vibration-induced change in the superimposed averaged traces corresponding to the distance of 2590 m, which results in the peak in the differential trace as shown in Figs. 3(b) and 3(d). Besides, enlargement of the differential trace demonstrates

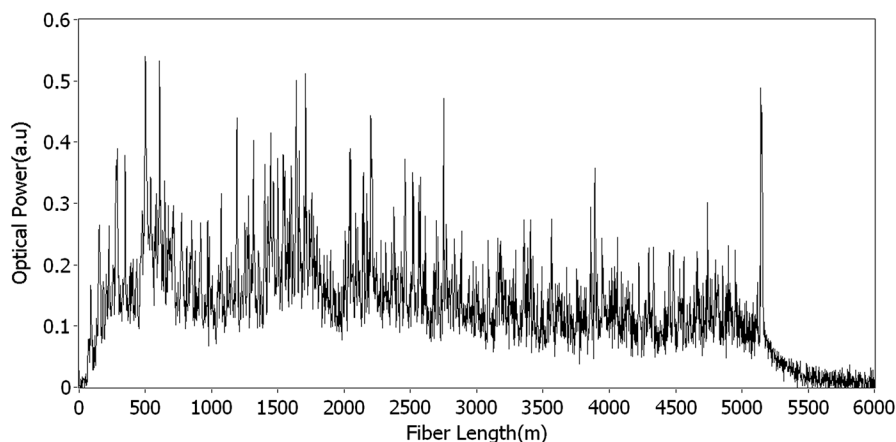

Fig. 2 The raw-backscattered trace acquired by the system.

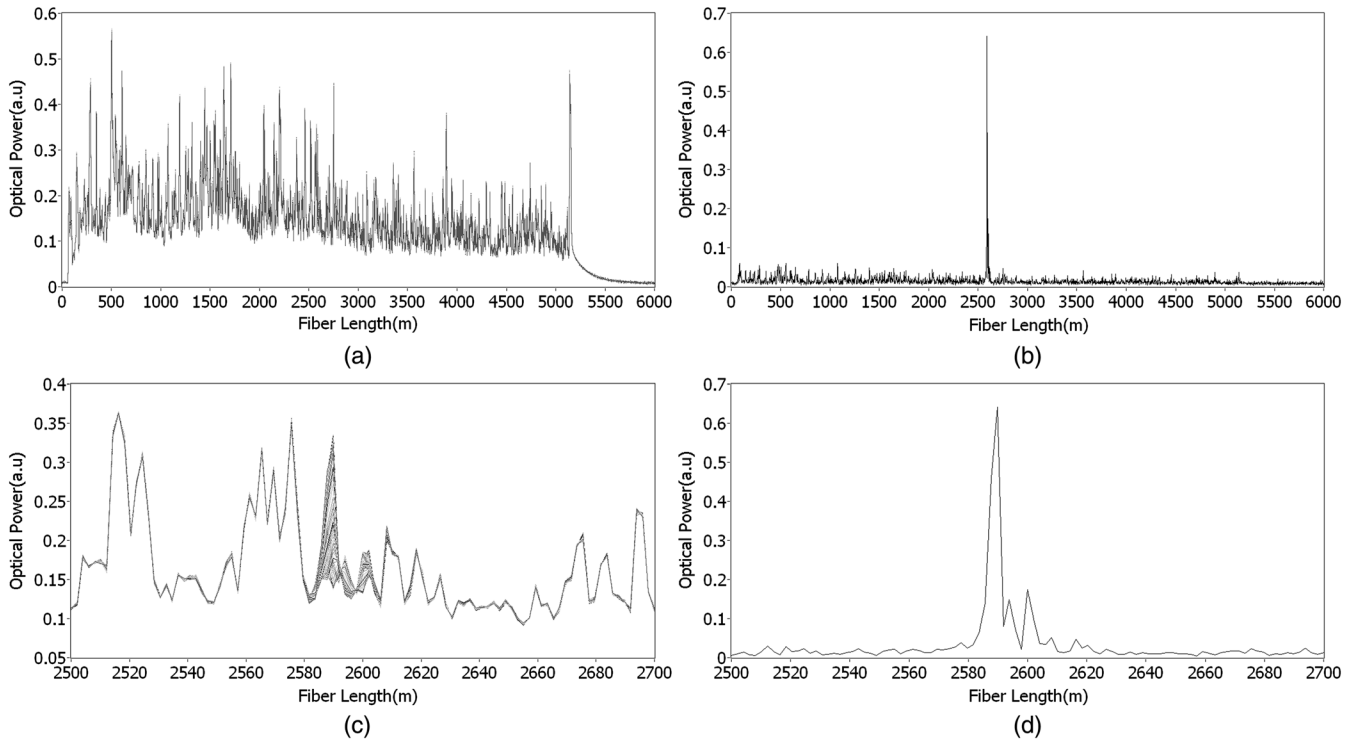

Fig. 3 Experimental results obtained with the signal processing method. (a, b) Superimposed averaged traces and differential trace in the range of the whole fiber length and (c, d) partial enlargement of (a) and (b).

the spatial resolution as 20 m, which verifies the correspondence between the pulse width and the spatial resolution.⁵

3 Polarization Modeling and Simulation Analysis

The SNR of our system is defined as $SNR = 10 * \log(V_s/V_n)$, where V_s and V_n represent the amplitudes of the vibration-induced peak and noises, respectively, in the differential trace. In our experiments, however, it was found that the signal SNR degenerates frequently under the same condition, but without the PC. As shown in Fig. 4, the SNR is just 3.5 dB. Therefore, the optical polarization model based on the equivalent Jones matrices of sensing fibers is established to investigate the polarization-induced fading in the system.

In nonideal conditions, due to the optical fiber’s defects, such as fiber core ellipticity, interior residual stress, and

external stress disturbance, two orthogonal polarization modalities of optical fiber cannot be mutually combined, and the birefringence phenomenon will happen. Taking the nonideal single-mode optical as a polarization device, the equivalent optical path of the system can be obtained, as shown in Fig. 5.

Since the relative positions and bending angles as well as the stress distribution of two sensing fibers are not the same, the sensing fiber birefringences are different, which eventually leads to inconsistency in their polarization characteristics. The Jones matrices of the two sensing arms can be represented as¹¹

$$G_1 = \begin{bmatrix} e^{j\xi} \sin x^2 + \cos x^2 & (e^{j\xi} - 1) \cos x \sin x \\ (e^{j\xi} - 1) \cos x \sin x & e^{j\xi} \cos x^2 + \sin x^2 \end{bmatrix} \quad (3)$$

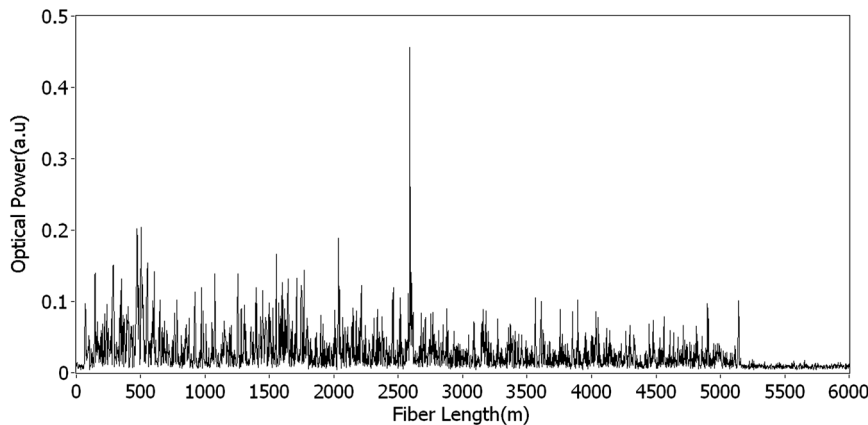

Fig. 4 The differential trace obtained without the PC.

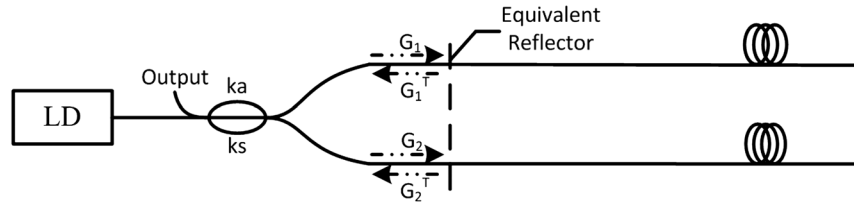

Fig. 5 Equivalent optical path of system.

$$G_2 = \begin{bmatrix} e^{j\xi'} \sin x'^2 + \cos x'^2 & (e^{j\xi'} - 1) \cos x' \sin x' \\ (e^{j\xi'} - 1) \cos x' \sin x' & e^{j\xi'} \cos x'^2 + \sin x'^2 \end{bmatrix}, \quad (4)$$

where ξ is the phase retardation angle and x is the angle between fast axis and x -axis. Taking no account of insertion and excess losses, when coupler's splitting ratio is 1:1, the direct coupling (ks) and cross-over coupling (ka) Jones matrixes can be expressed as¹²

$$ka = \begin{bmatrix} i\frac{\sqrt{2}}{2} & 0 \\ 0 & i\frac{\sqrt{2}}{2} \end{bmatrix}, \quad ks = \begin{bmatrix} \frac{\sqrt{2}}{2} & 0 \\ 0 & \frac{\sqrt{2}}{2} \end{bmatrix}. \quad (5)$$

The system input light can be represented by the Jones vector:

$$E_{in} = \begin{bmatrix} E_x \\ E_y \end{bmatrix} = E_0 \begin{bmatrix} \cos \varphi \cos \varepsilon - j \sin \varphi \sin \varepsilon \\ \sin \varphi \cos \varepsilon + j \cos \varphi \sin \varepsilon \end{bmatrix}, \quad (6)$$

where E_0 denotes the lightwave amplitude and φ and ε are the azimuth and ellipticity angle, respectively, which determine the input polarization state together.

Assuming that the forward and backward equivalent Jones matrixes of the two sensing arms are separately G_1 , G_2 and G_1^T , G_2^T , which are determined by polarization property of the sensing fiber,¹² then according to the equivalent optical path, as shown in Fig. 5, the optical signal detected by APD can be represented by

$$E_{out} = (ka \times G_1^T \times G_1 \times ks + e^{j\delta} \times ks \times G_2^T \times G_2 \times ka) \times E_{in}, \quad (7)$$

where δ is the phase retardation difference between two sensing fibers caused by disturbance. The light intensity can be represented by

$$I = |E_{out}|^2 = |E_{ox}|^2 + |E_{oy}|^2, \quad (8)$$

where E_{ox} and E_{oy} are the x - and y -axial components of the output light, respectively. Substituting Eqs. (3)–(7) to Eq. (8), the function of light intensity can be obtained as

$$I = f(\xi, x, \xi', x', \delta, \varphi, \varepsilon). \quad (9)$$

Since ξ , x , ξ' , and x' can be regarded as constant when the fibers are set up, the light intensity can be emulated with δ , φ , and ε as variables. Supposing the alternate phase retardation caused by vibration events is $\delta = 4 + \sin(t)$ and $\xi = 1.56\pi$, $x = 0.8\pi$, $\xi' = 0.36\pi$, $x' = -1.14\pi$, Fig. 6 shows the various interference light intensity in different input light polarization states, which are linearly polarized ($\varphi = 0.25\pi$, $\varepsilon = 0$), elliptically polarized ($\varphi = 0.25\pi$, $\varepsilon = 0.25\pi$), and circularly polarized ($\varphi = 0.25\pi$, $\varepsilon = 0.125\pi$), respectively.

From Fig. 6, we can tell that due to the inconsistency of the polarization properties of two sensing fibers, the same vibration source may result in signals with different amplitudes for different polarization states of the incident light. Besides, the amplitude varies a lot at different times even when the incident light has a determined polarization state, and that is the cause of SNR decrease in the differential signals. Therefore, the PC is employed with appropriate setting of which the differential trace is just as Fig. 3 shows, in which the SNR is 9.5 dB.

4 Conclusion

A novel phase-sensitive OTDR configuration based on two beam interference along with the signal processing scheme was proposed and experimentally demonstrated. In order to solve the polarization-induced fading problem that occurred in experiments, the optical polarization model based on the equivalent Jones matrixes of sensing fibers was established and gives a solution. Experimental results showed that with the employment of the PC, the signal SNR can be stabilized

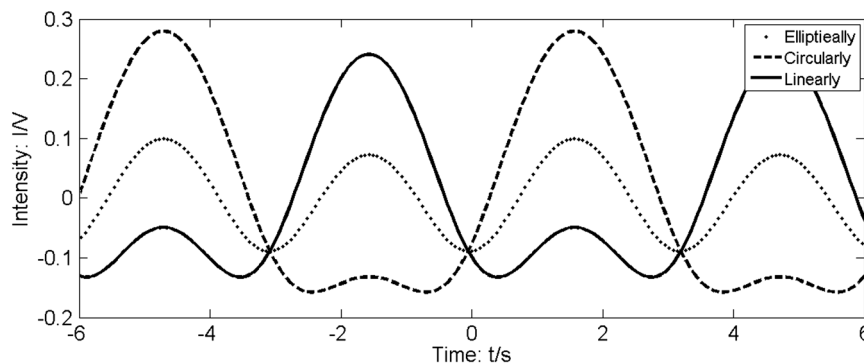

Fig. 6 Interference light intensity in different input polarization states.

as high as 9.5 dB, and a validated optimal spatial resolution of 20 m is acquired under testing fiber length of 5 km. The system eliminates the dependence on the expensive ultra-narrow line-width laser source, which is necessary in the traditional phase-sensitive OTDR, and can be applied to structure health monitoring and pipeline security prewarning requirements.

Acknowledgments

This work is funded by the National Natural Science Foundation of China (No. 61240038).

References

1. X. Y. Bao and L. Chen, "Recent progress in distributed fiber optic sensors," *Sensors* **12**(7), 8601–8639 (2012).
2. H. F. Tarlor and C. E. Lee, "Apparatus and method for fiber optic intrusion sensing," U.S. Patent 5194847 (1993).
3. W. Seo, "Fiber optic intrusion sensor investigation," Ph.D. Dissertation, Department of Electrical Engineering, Texas A&M University (1994).
4. K. N. Choi and H. F. Taylor, "Spectrally stable Er: fiber laser for application in phase-sensitive optical time-domain reflectometry," *IEEE Photon. Technol. Lett.* **15**(3), 386–389 (2003).
5. Y. Lv and Y. Xing, "Investigation on Rayleigh scattering waveform in phase optical time domain reflectometer," *Acta Opt. Sin.* **31**(8), 235–239 (2011).
6. J. C. Juarez and H. F. Taylor, "Field test of a distributed fiber-optic intrusion sensor system for long perimeters," *Appl. Opt.* **46**(11), 1968–1971 (2007).
7. Y. L. Lu et al., "Distributed vibration sensor based on coherent detection of phase-OTDR," *J. Lightwave Technol.* **28**(22), 3243–3249 (2010).
8. Z. G. Qin et al., "High sensitivity distributed vibration sensor based on polarization-maintaining configurations of phase-OTDR," *IEEE Photon. Technol. Lett.* **23**(15), 1091–1093 (2011).
9. Z. G. Qin, L. Chen, and X. Y. Bao, "Wavelet denoising method for improving detection performance of distributed vibration sensor," *IEEE Photon. Technol. Lett.* **24**(7), 542–544 (2012).
10. S. V. Shatalin, V. N. Treschikov, and A. J. Rogers, "Interferometric optical time-domain reflectometry for distributed optical-fiber sensing," *Appl. Opt.* **37**(24), 5600–5604 (1998).
11. J. H. Zhang, "General expression of Jones Matrix in birefringent fibers and reflective transmission characteristics," *Acta Photon. Sin.* **26**(6), 527–531 (1997).
12. J. Tan, W. M. Chen, and Y. M. Fu, "Application of Jones Matrix in the research of polarization effects of the distributed optic fiber sensor," *Opto-Electron. Eng.* **34**(2), 120–125 (2007).



Yang An is currently pursuing the PhD degree with the State Key Laboratory of Precision Measurement Technology & Instruments, Tianjin University, Tianjin, China. His research interests include distributed optical fiber sensors for dynamic measurement and signal processing.

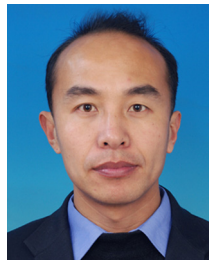

Jian Li received the PhD degree in precision instrument and mechanism specialty from Tianjin University, China. He is currently with the State Key Laboratory of Precision Measuring Technology & Instruments, Tianjin University, China, as an associate professor. His research interests include non-destructive testing and signal processing.

Biographies and photographs of the other authors are not provided.