

International Conference on Space Optics—ICSO 2000

Toulouse Labège, France

5–7 December 2000

Edited by George Otrio

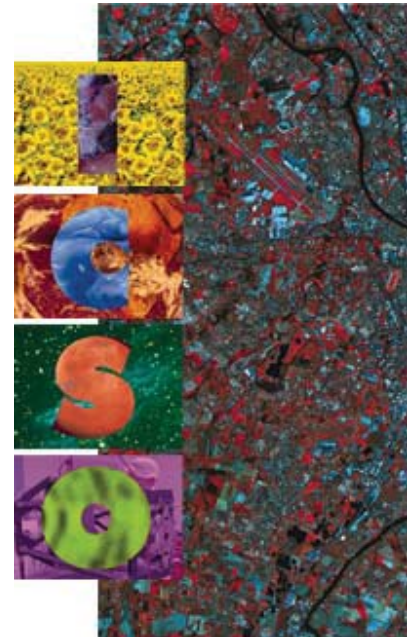

A very wide band telescope for Planck using optical and radio frequency techniques

*Guy Fargant, Denis Dubruel, Myriam Cornut,
Jean-Bernard Riti, et al.*



ics0 proceedings



A very wide band telescope for Planck using optical and radio frequency techniques

Guy Fargant^(a), Denis Dubruel^(a), Myriam Cornut^(a), Jean-Bernard Riti^(a)
Thomas Passvogel^(b), Peter De Maagt^(b), Michel Anderegg^(b), Jan Tauber^(b)

^(a) Alcatel Space Industries, Cannes, France

^(b) European Space Agency, Noordwijk, The Netherlands

ABSTRACT

Planck associated to FIRST is one of the ESA scientific missions belonging to the Horizon 2000 programme. It will be launched by an Ariane 5 in 2007. Planck aims at obtaining very accurate images of the Cosmic Microwave Background fluctuations, thanks to a spaceborne telescope featuring a wide wavelength range and an excellent control of straylight and thermal variations.

The telescope is based on an off-axis gregorian design consisting of two concave ellipsoidal mirrors with a 1.5-meter pupil, derived from radio frequency antenna, but with a very wide spectral domain which ranges from far infrared (350 μm) up to millimetric wavelengths (10 mm). Its field of view is large (10 degrees) owing to a high number of detectors in the focal plane. The short wavelength detectors (bolometers operating at 0.1 K) are located at the centre of the focal plane unit while the long wavelength ones (based on HEMT amplifier technology operating at 20 K) are located at the periphery.

The Planck telescope operates at a temperature below 60 K. This level is achieved in a passive way, i.e. using a cryogenic radiator. Furthermore, this radiator must accommodate a set of coolers dedicated to the focal plane unit, cooling one of the experiments down to 0.1 K.

The Planck mission leads to very stringent requirements (straylight, thermal stability) that can only be achieved by designing the spacecraft at system level, combining optical, radio frequency and thermal techniques in order to achieve the required performance.

Keywords : Space, Telescope, Infrared, Antenna, Radio frequency.

1. INTRODUCTION

FIRST-Planck is one of the European Space Agency (ESA) scientific missions which belong to the Horizon 2000 programme. It combines the FIRST and the Planck missions within one single programme.

The Far Infrared and Sub-millimetre Telescope (FIRST) is dedicated to perform astronomical observations in the far-infrared and sub-millimetre wavelength range. FIRST, the fourth ESA cornerstone mission is a multi-user observatory type mission.

Planck will image the temperature of anisotropies of the Cosmic Microwave Background (CMB) over the whole sky with a sensitivity of $\Delta T/T < 2 \times 10^{-6}$ and an angular resolution of 10 arc-minutes. Planck is the third medium size mission (M3) in ESA's long-term scientific plan Horizon 2000.

Planck will be launched from the European Space Port Kourou by an Ariane 5 in 2007 and operated during 14 months at the L2 Lagrangian point (see figure 1). The aims of Planck are to obtain definitive images of the CMB fluctuations and to extract the primordial signal to high accuracy from contaminating astrophysical source of emission. This can be achieved by a space telescope having a wide frequency coverage and excellent control of systematic errors (e.g. straylight and thermal variations).

The Planck payload operates in nine frequency channels ranging from 25 GHz to 1000 GHz. To reach the challenging unprecedented sensitivity, the Planck detectors, High Electron Mobility Transistors (HEMT) for the 25 to 100 GHz channels and bolometers for the 100 to 1000 GHz channels, are cooled down to 20 K respectively to 0.1 K. The detector horns are distributed over the focal surface of an off-axis telescope operating at a temperature between 30 K and 60 K. The telescope has a 1.5 meter diameter projected aperture and consists in two ellipsoidal mirrors.

The main performance of the Planck spacecraft is the result of the optical performance of its telescope combined with its capacity to reject parasitic signals characterised by the Straylight Induced Noise (SIN [4]). This paper will describe the methods, tools and results obtained by Alcatel to assess this performance.

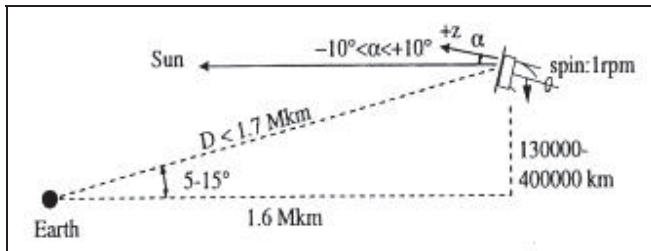

Figure 1 : Planck will scan the sky at the second Lagrangian point L2 at about 1.7 Mkm from the Earth.

2. GENERAL DESCRIPTION

2.1. The telescope

The optics of the instrument is derived from a classical radio frequency (RF) antenna design (see figure 2.a). It is an off-axis gregorian telescope with two reflectors : a large elliptical primary mirror which dimensions are 1.9 x 1.5 m and a smaller elliptical secondary one which dimensions are 1 x 0.8 m. An angle of 10° has been introduced between the mirrors axes. The pupil situated on the first mirror has a projected aperture diameter of 1.5 m seen from the centre of the field of view which width is 10°. The pupil is offset of 1.5 m and the centre of the field of view is shifted of 3.8° from the primary mirror axis. The central wavelength of the spectral channels ranges from 0.350 mm (957 GHz) to 10 mm (30 GHz). The telescope has been optimised to improve the image quality in the whole field of view. The angular resolution on the sky is better than 13 arcmin for a wavelength of 3 mm (100 GHz).

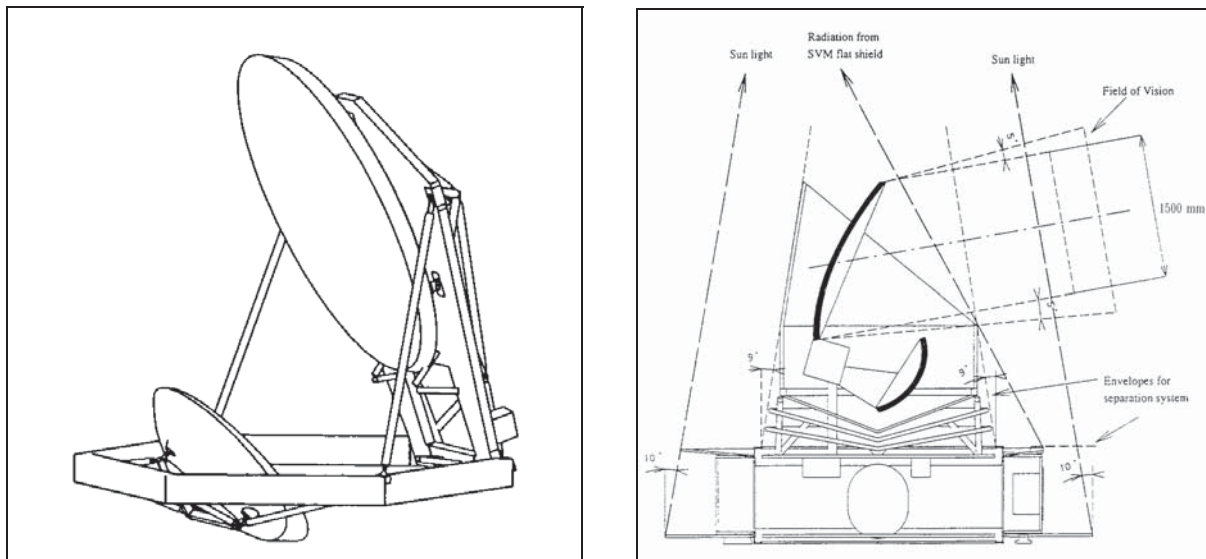

Figure 2.a : The optical design of the telescope is derived from an off-axis gregorian.

2.2 The focal plane unit

The focal plane unit (FPU) is composed of two sets of detectors (see figure 2.b) : the high frequency instrument (HFI) and the low frequency instrument (LFI). The HFI covers the wavelength spectral domain from 0.35 mm to 3 mm and is situated at the centre of the field of view where the telescope image quality is the best. The LFI wavelength ranges from 3 mm to 10 mm and the detectors are placed at the periphery of the field of view. The two units are built separately and are merged during integration.

The heart of the HFI (see figure 2.b left) are bolometers designed to cover the 100-857 GHz band. They are solid state devices in which the incoming radiation dissipates its energy as heat that increases the temperature of a thermometer. The number of bolometers is 48, split into a total number of 6 channels at a central frequency of 100, 143, 217, 353, 545 and 857 GHz. The corresponding angular resolution at -3 dB varies from 1.6 arcmin to 10.5 arcmin. The temperature of the bolometers is as low as 0.1 K. It is the most sensitive part of the instrument. The detection subsystem integrates feedhorns, spectral filters, solid state detectors and the cold end unit of the cooling subsystem.

The LFI (see figure 2.b right) is designed to cover the 30-100 GHz band with an array of 28 detectors split into 4 channels, centred at 30, 44, 70 and 100 GHz. The total power receivers are based on monolithic microwave integrated circuits (MMIC). Amplification stage is provided by high energy mobility transistors (HEMT) which are actively cooled at a temperature of 20 K. This technology offers at present time, the best compromise between sensitivity and ease of implementation in the frequency range of the LFI. The angular resolution at -3 dB ranges from 13 arcmin to 33 arcmin. The radiation is coupled from the telescope to the detectors through conical corrugated feedhorns.

The mechanical layout of the detectors must fit the telescope focal surface characteristics. The axis of the horns corresponds to the chief ray of the telescope and the centre of phase of the horns is placed on the focal surface.

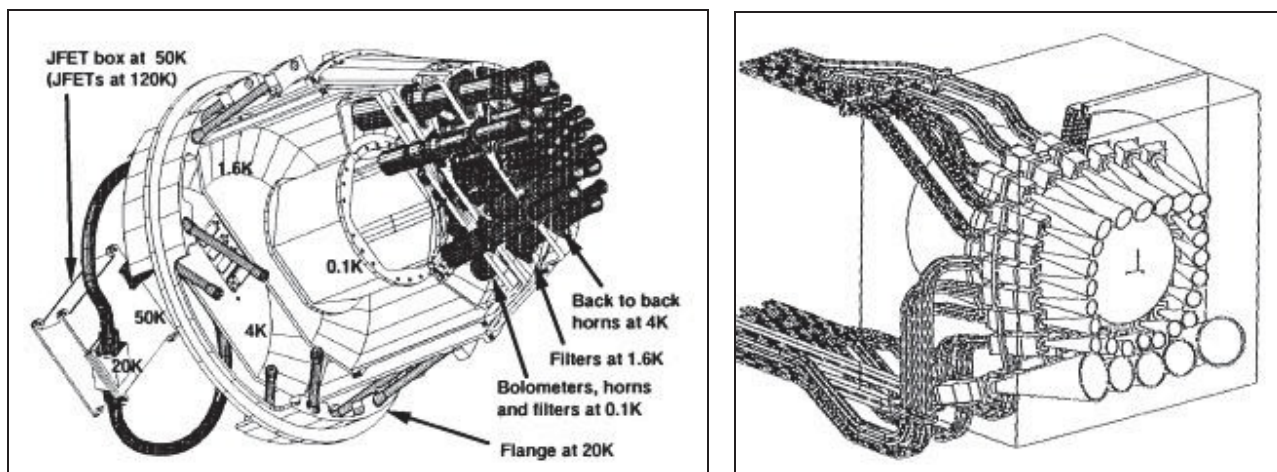

Figure 2.b : The focal plane unit of the instrument - HFI (left) and LFI (right).

2.3 The satellite

The general architecture of the spacecraft is shown on figure 2.c. The satellite is spin stabilised at one round per minute and the sun direction can be at $\pm 10^\circ$ with respect to the spin axis. The main requirements which have driven the satellite design are the passive temperature level of 60 K that must be reached at the telescope level and the thermal variations and straylight source perturbations which must be minimised on the payload. It is mainly composed of a service module (SVM) and a payload module (PLM). The SVM provides the interfaces to the launcher. It contains the active cooling systems of LFI and HFI and the equipments to operate the satellite. The solar array is fixed on its lower face. The operational temperature of the SVM is around 300 K. The telescope structure is composed of an hexagonal frame and a main panel which support the reflectors and the focal plane unit. The operational temperature of the telescope is 60 K. Its conductive thermal discoupling from the SVM is provided by the GFRP (Glass Fiber Reenforced Plastic) intermediate structure and the radiative discoupling by three conical aluminium shields, called 'grooves'. The SVM shield prevents the telescope from sun direct illumination. It also avoids thermal straylight radiations of the SVM to enter into the main baffle by diffraction effects on its rim. The telescope is surrounded by the main baffle which protects it from external straylight radiations coming from the sky. The whole satellite size will be about 3.8 m high and 4.5 m for its maximum diameter.

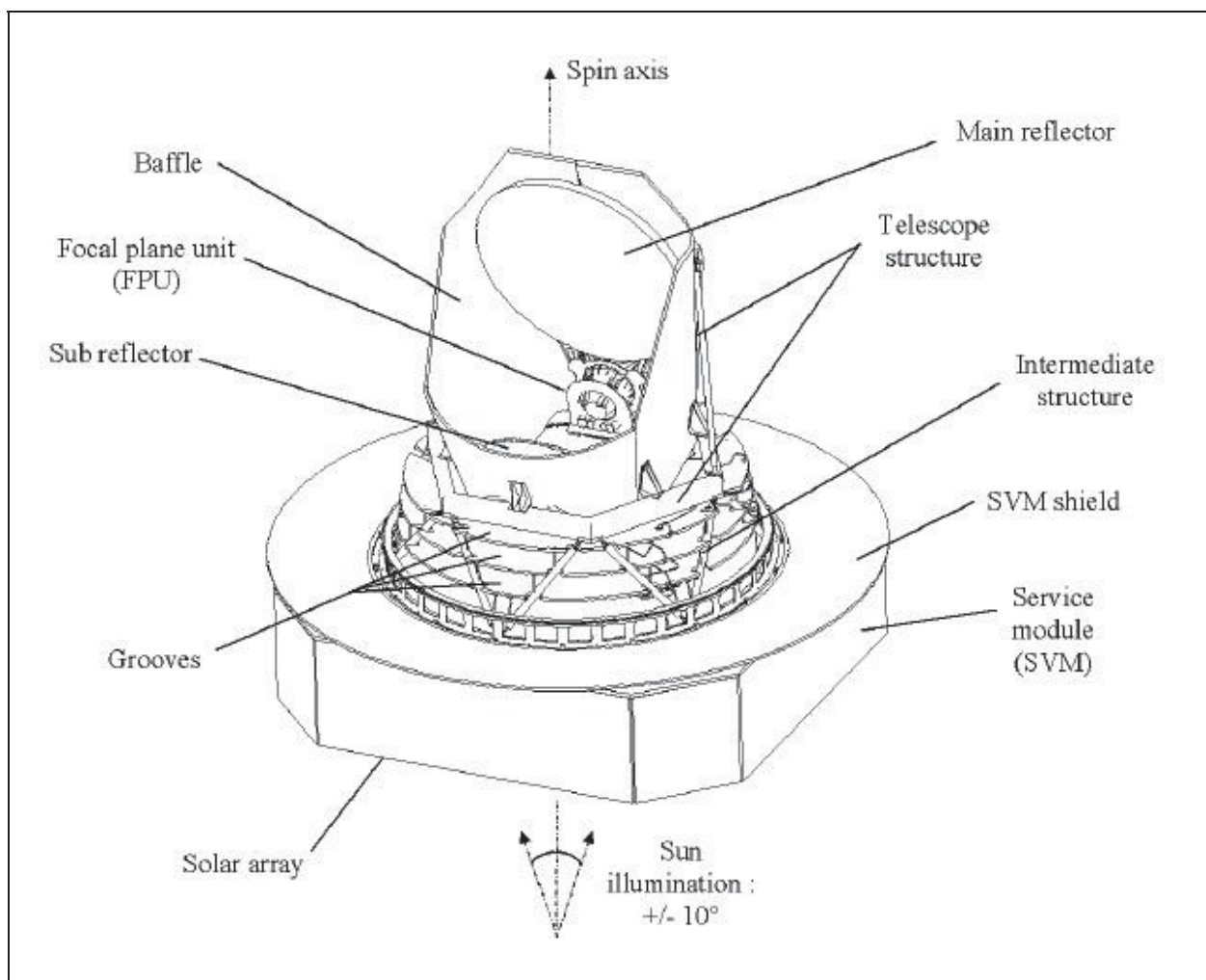

Figure 2.c : Architecture design of the satellite.

3. TELESCOPE OPTIMISATION

In order to optimise and compute the telescope performance a four step sequential approach has been selected :

- i) Telescope optimisation with gaussian beam aiming at reducing the wavefront error (WFE) with an optical software : CODE V [1],
- ii) Telescope sensitivity analysis with gaussian beam using another optical software : ASAP [2],
- iii) Telescope far field radiation pattern computation over the whole space (4π steradians) with actual feed horn diagrams using a RF software : GRASP8 [3],
- iv) Straylight induced noise computation resulting from the convolution between the sky map temperature and the far field radiation pattern.

The Planck antenna was initially designed like an off-axis gregorian telescope. The primary reflector was a paraboloid and the secondary reflector was an ellipsoid. The image quality in the centre of the field of view was perfect but at the edge it was degraded because the telescope was not aplanatic. The consequence is that the gain (and the Strehl ratio) for the outer horns of the focal plane is much reduced and the point spread function (PSF) is irregular. The question which arose was : is it possible to optimise the telescope so that the image quality is improved at the edge of the field and not degraded in the centre?

Three softwares were considered to make the optimisation : GRASP8, ASAP and CODE V. GRASP8 is a radio frequency software developed for calculation of telecommunication antenna pattern but cannot handle the very high frequencies. It works by wave propagation and it is the software reference in Europe for RF analysis. ASAP is a general optical software which works by ray tracing but has no built-in optimisation routine. CODE V is also an optical software which is devoted to analyse and optimise all types of optical systems, so it has been chosen for the telescope improvement. It works by ray tracing and it is the software reference in the world for optical design and analysis.

A gaussian apodisation is used for the optimisation and PSF computation. It is defined from the actual feed horn diagrams taking the gaussian which has the same angular width at the level of -30 dB. Figure 3.a displays the far field radiation pattern of the feed horns at 353, 100 and 30 GHz. For 353 GHz the total width is 38.8° , it is 43.8° for 100 GHz and 47.2° for 30 GHz. The outside part of the radiation pattern is not well modelised by a gaussian shape but it has no impact on the optimisation result as the energy is very low.

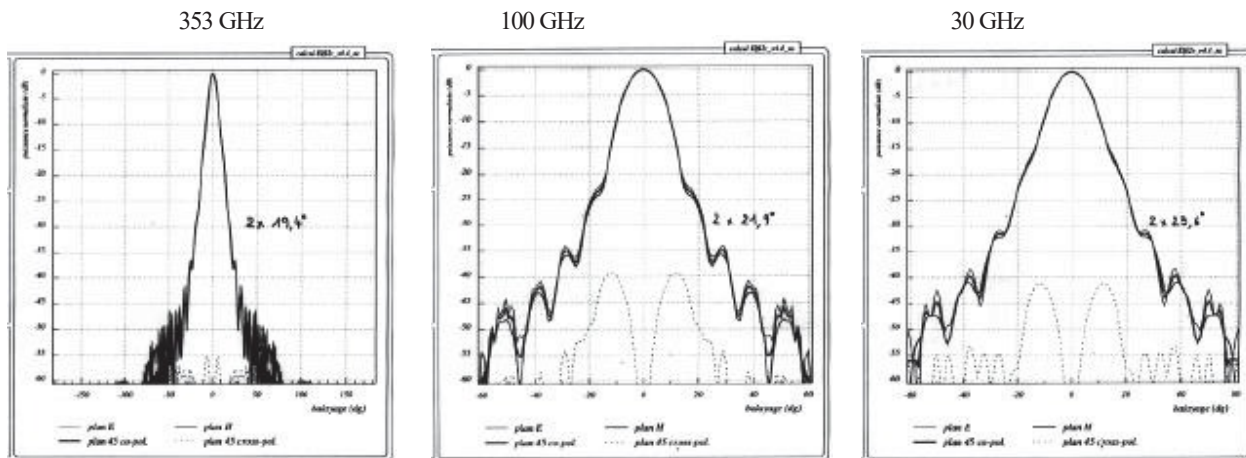

Figure 3.a : Far field radiation pattern of the feed horns at 353, 100 and 30 GHz.

To check the validity of CODE V relatively to GRASP8 it was necessary to compare first the analysis results of both softwares on a same configuration which was the initial off-axis gregorian telescope. 16 horns among a total of 76 have been chosen to make the comparison. The PSF of these horns were calculated with both softwares for the frequencies ranging from 30 to 353 GHz. The two higher frequencies 545 and 857 GHz were not considered. After calculation, the contour lines at -3 dB and -20 dB of the PSF of both softwares were traced and compared. It appeared that the shape, the orientation and the size of the PSF were globally the same.

The optimisation was first performed starting from an aplanatic solution which was calculated in the third order theory to zero out the spherical aberration and the coma. Then the actual optimisation was undertaken on 16 field points (8 for HFI and 8 for LFI). The merit function used was based on the quadratic sum of the wavefront error (WFE) of the 16 fields and a gaussian apodisation was applied at the horn level. The optimisation has consisted in minimising the merit function with added constraints.

The telescope parameters which were allowed to vary during the optimisation were the conic constants of the mirrors, the radius of curvature of the secondary mirror, the distance between primary and secondary mirrors, the angle between mirrors axes, the pupil offset distance with respect to vertex of the primary mirror, the angle of the centre of the field of view with respect to the primary mirror axis and the shape of the focal surface. Constraints on the taper angle of each horn were added to limit the straylight induced by the spill-over. In addition geometrical parameters constraints on top level system architecture have been introduced (e.g. FIRST interface cylinder, maximum allowed height, etc...). The aim is to have a design directly compatible with the spacecraft.

The optimisation provides a new design in which the two reflectors shape are now part of ellipsoids (see figure 3.b). The PSF are then calculated with CODE V and GRASP8. It comes out that, as for the initial solution, the PSF of both softwares are very similar and a great improvement of the regularity has appeared along with higher antenna gains for the outer horns (see figure 3.c). Table 3 also shows typical performance obtained on the new design for some horns used during the optimisation. These horns are diffraction limited i.e. WFE are lower than 0.077λ and the corresponding Strehl ratios are greater than 0.8. The ellipticity and the angular resolution at -3 dB have also been calculated from the PSF.

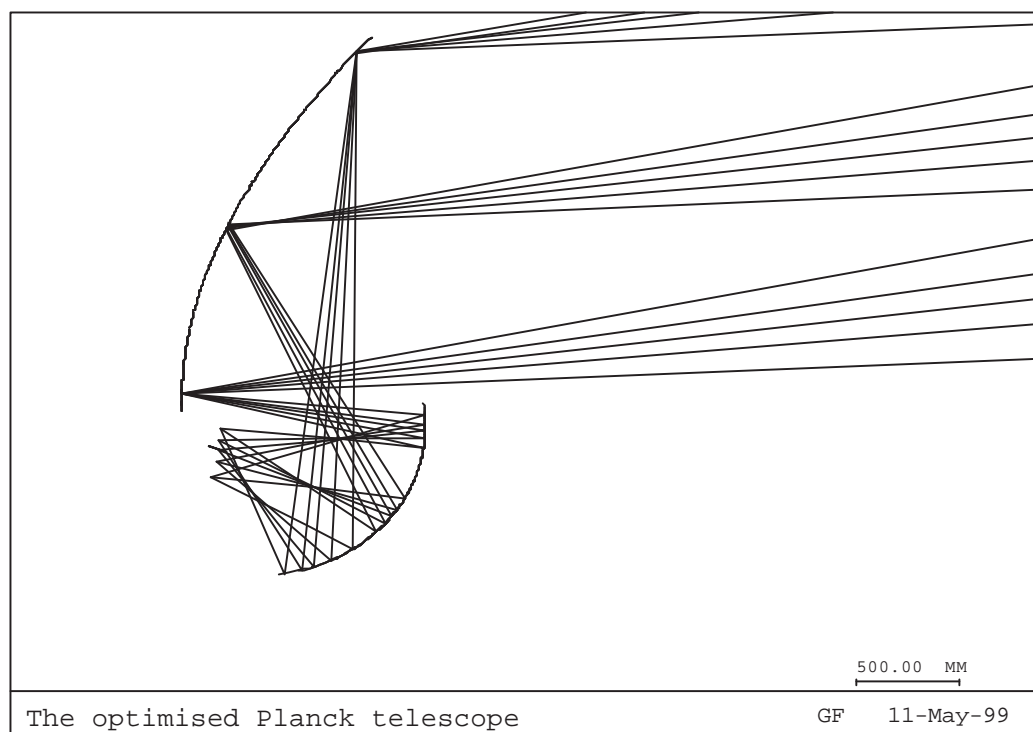

Figure 3.b : Optical design of the optimised telescope.

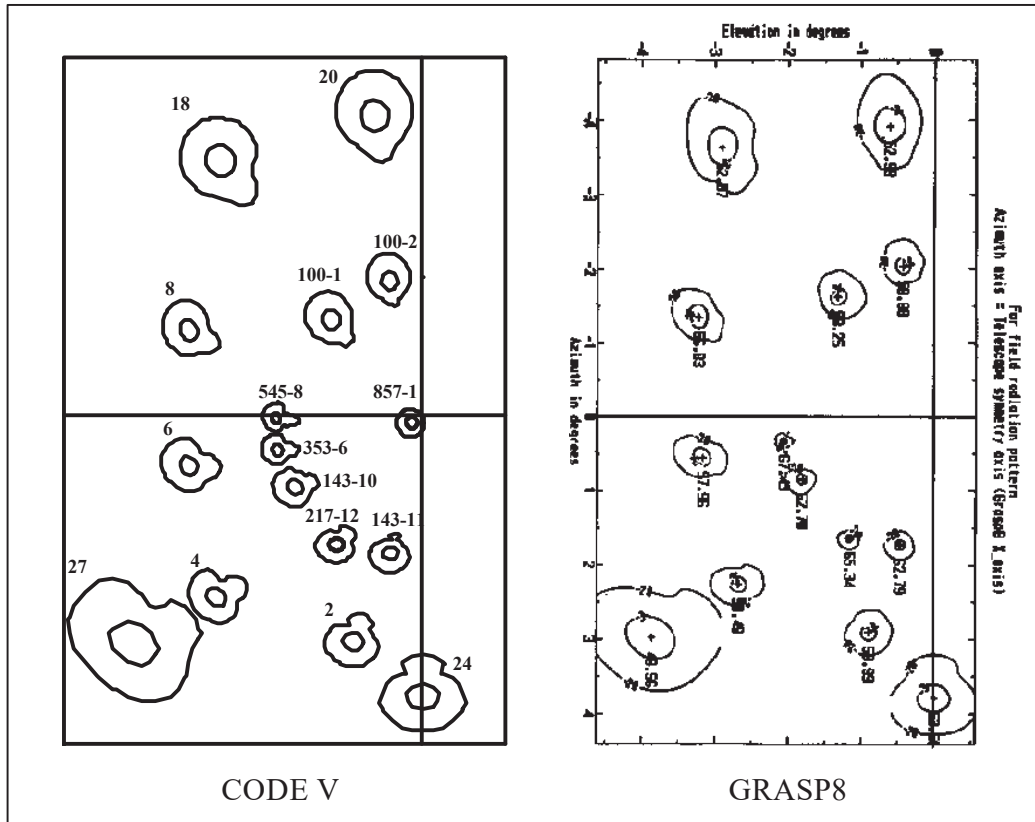

Figure 3.c : Comparison of the PSF computed by CODE V (left) and GRASP8 (right) on the new design.

Horn Frequency (GHz)	Wavelength (mm)	Taper angle at -30 dB (deg)	WFE RMS (wave)	Strehl ratio	Ellipticity at -3 dB	Resolution at -3 dB (arcmin)
HFI						
857	0.35	19.4	0.069	0.829	1.02	1.6
143	2.10	23.7	0.032	0.960	1.19	7.5
100	3.00	26.8	0.035	0.953	1.06	10.4
LFI						
100	3.00	21.9	0.063	0.855	1.23	12.0
30	10.00	23.6	0.049	0.910	1.39	33.4

Table 3 : Performance obtained on the optimised telescope for some horns.

In order to define the manufacturing tolerances, the integration accuracy and the stability of the mirrors and of the structure, a sensitivity analysis has been performed using ASAP software. For this purpose the deviation of the design parameters has been computed so that the induced WFE is equal to 30 μm RMS. Then a WFE budget has been done leading to a total WFE of 83 μm RMS corresponding to a diffraction limited telescope at 217 GHz.

4. STRAYLIGHT INDUCED NOISE

The relevant effects that contribute to straylight can be visualised by tracing representative rays. Figure 4.a shows the main paths of the rays which arrive to the focal plane directly or by diffracting. The rays hit the detectors in a direction corresponding to the side lobes of the feedhorns. Direct rays arrive just around the secondary mirror or by reflecting on its rim. The diffraction effects occur at the edge of the main shield and at the edge of the primary reflector. Also internal reflections can participate in straylight.

The straylight induced noise is defined as the signal arriving to detectors through side lobes. Three major straylight components can be determined, the galactic SIN, the planet SIN and the internal SIN. The galactic SIN is obtained by convolution of the telescope far field radiation pattern with the galactic map temperature knowing the satellite kinematics. The SIN induced by planets is obtained by determination of their trajectory in the far field radiation pattern. The internal SIN is obtained by computation of the incident RF power variation due to thermal fluctuations over all the spacecraft structural parts.

The most difficult point to compute the SIN is the far field radiation pattern calculation over all space directions. The ray tracing method used by a software like ASAP is perfectly suitable for the main beam but not for far outside lobes. Hence an electromagnetic modelling approach is selected, induced currents on the reflector are computed using the physical optics approximation. This approach requires to mesh the radiating surfaces, the meshing is nevertheless dependant on the wavelength. At 30 GHz the primary reflector has a size of 150 wavelengths whereas at 353 GHz it is 1766 wavelengths. The physical optics approach can only be dedicated to low frequencies. This analysis is then performed using the physical optics method implemented in GRASP8.

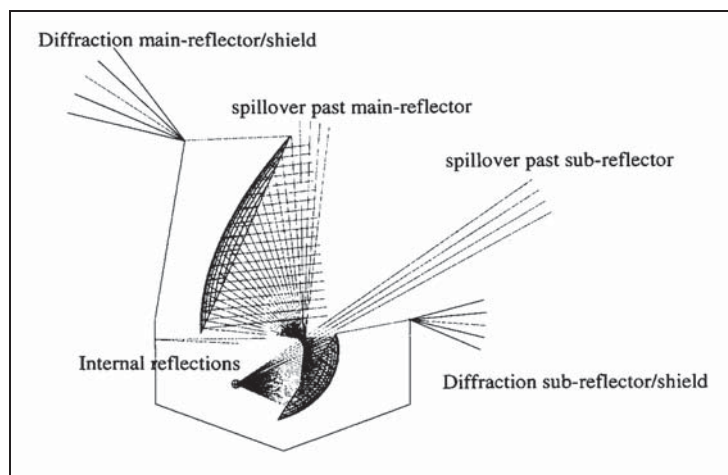

Figure 4.a : Sketch of the telescope and shield showing representative rays contributing to straylight.

Figure 4.b (left) illustrates the far outside lobe at 30 GHz. The main lobe peak gain is around 50 dBi, the overall gain dynamic is 100 dBi. A diagram integration shows that most of the energy is comprised within the main lobe area. This energy by definition does not contribute to the SIN. The challenge is to determine with the best accuracy the energy contained outside the main lobe.

The telescope is surrounded by a baffle which allows to modify the far outside lobe dispatching, especially toward the planets ($\theta=90^\circ$ in cut $\varphi=0^\circ$). Figure 4.b (right) shows the telescope far field radiation pattern with the baffle and the significant attenuation obtained which impact has also been computed using a physical optics method at 30 GHz.

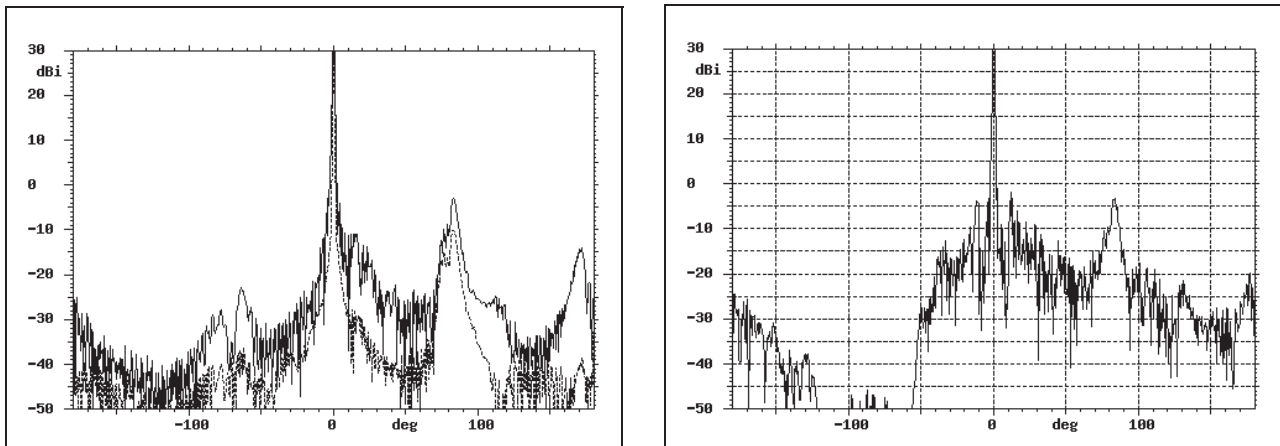

Figure 4.b : Telescope far field radiation pattern for $\phi=0^\circ$ at 30 GHz without baffle (left) and with baffle (right).

The galactic SIN is then computed by simulating the mission knowing the satellite kinematics and the sky map temperature. Figure 4.c displays the projected sky map temperature with some circles corresponding to the main beam trajectory in the sky. Figure 4.d is the galactic SIN results for every circle for the whole duration of the mission. It corresponds to the integrated noise temperature for the side lobe only. Each point of the figure corresponds to the convolution of the sky temperature map with the field radiation pattern of the telescope for a particular attitude of the satellite. The maximum noise temperature due to galactic straylight is below $10 \mu\text{K}$.

Finally a Fourier spectral analysis is performed on the SIN map and compared to the maximum allowed noise level. This work is still going on.

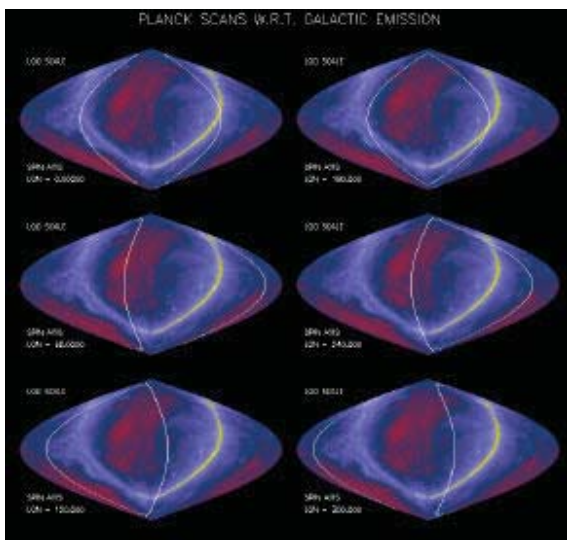

Figure 4.c : Scanning of the Planck telescope on the sky map temperature (sinus projection).

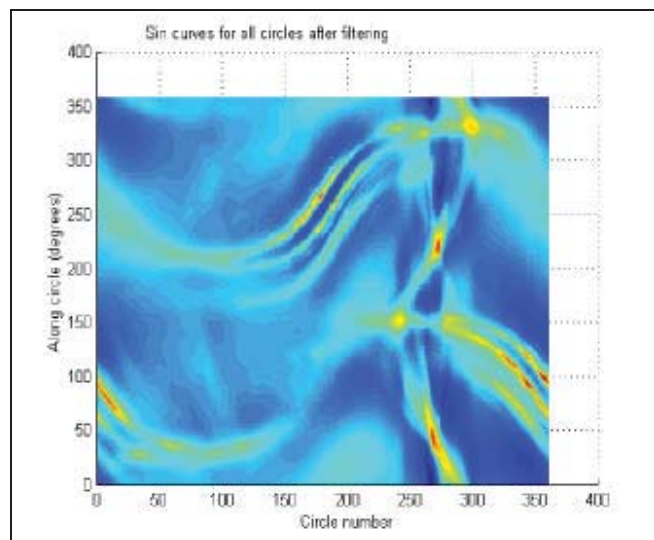

Figure 4.d : The galactic SIN is the convolution result of the telescope far field radiation pattern with the sky map temperature.

5. THERMAL ANALYSIS

The internal SIN determination requires as input the temperature cartography of the spacecraft. The required input data is not only the steady state case result, but the temperature fluctuations law over the time. Temperature fluctuations are due to variations of heat power absorbed by the satellite as well as heat power dissipated by the satellite. The absorbed power variation may be broken down into two contributions : the first one is the variation of the external environment due to the satellite orbit around the sun, and the second one is the satellite absorption variation due to its own attitude on the orbit. An orbit around the L2 Lagrangian point is particularly well suited to minimise temperature fluctuations due to the external environment. Indeed, the planets and albedo flux are negligible, including the Earth.

The satellite part subject to the solar flux is the solar array. The solar array design is as symmetrical (and flat) as possible around the spin axis (except for thrusters, TMTC antennas...). This design allows to minimise the solar power variation absorbed by the satellite during the spacecraft spinning. Nevertheless a fluctuation level appears when the satellite spin axis is tilted from the sun direction (the worst case being 10 °). This kind of source at a spin period of 60 s must be carefully studied. The main power variation source comes from one of the payload cooler. This fluctuation source period is 667 s. The only way to limit the impact is to optimise the component mass, in order to get a high specific heat value (thermal inertia) compatible with the mechanical requirements. The output of the thermal analysis are directly used to determine the internal SIN.

The LFI detectors, based on HETM amplifier technology, need to be cooled down to 20 K. This temperature level is obtained thanks to a so called «sorption cooler», developed by the Jet Propulsion Laboratory. It is basically a Joule-Thomson cooler. In this kind of system, gas expands from high pressure to low pressure at constant enthalpy and thereby experiences a decrease in temperature. The sorption cooler for PLANCK presents the characteristics to be vibration free, as the gas is compressed in a chemical way.

The detectors for the HFI are bolometers and operate at 0.1 K. To reach this temperature, a $^3\text{He}/^4\text{He}$ dilution cooler is used. This technology is developed for spatial applications by the «Centre de Recherches sur les Très Basses Températures - CNRS - France ». To operate properly, the cooler needs a pre-cooling stage at 4 K. This temperature is obtained with an additional Joule-Thomson system, using mechanical compressors. The fluids used by each of these three coolers are pre-cooled from ambient temperature (storage temperature) to around 60 K by thermal anchoring on the three temperature stages of the payload module. Inside the FPU, the philosophy to respect is that each temperature stage must be surrounded by a environment as cold as possible, for both a reduction of the thermal loads and efficient cooling of the fluids.

6. CONCLUSION

The Planck satellite, one of ESA's main missions for this decade, has been designed to help answer key questions for humankind : how the universe came to be and how it will evolve. To fulfil its mission Planck will examine the first light that filled the universe after the Big Bang, the so-called Cosmic Microwave Background radiation. Planck has to measure the temperature of this radiation all over the sky, with enough sensitivity to detect variations a million times smaller than a degree. The problem is that many astronomical objects and even the satellite itself, emit radiations that are much more intense than the cosmic background and that can therefore hide its signature altogether.

Planck will carry two arrays of highly sensitive detectors that are now being built by more than 40 institutes, most of them are european and some are from the United States. It will be launched in 2007 together with ESA's far-infrared space telescope, FIRST. They will separate shortly after the launch and will be operated independently at similar orbits located about 1.7 million kilometres away from Earth.

A study has been carried out taking the actual launcher constraints (mechanical allowed volume) as first parameters. Then an optical optimisation has been performed to improve the image quality in parallel to a detailed thermal analysis over the actual structural parts of the spacecraft. Then a final RF analysis associated to a post processing has allowed to determine the final performance in term of straylight induced noise. The SIN was computed at the wavelength of 10 mm. The spacecraft design at system level, combining optical, radio frequencies and thermal techniques in order to achieve the best performance, will enable the scientists to determine to high accuracy the fundamental parameters defining our universe.

ACKNOWLEDGMENTS

This work was supported by the ESA FIRST-Planck programme. We gratefully acknowledge the efforts of Alcatel staff and the contribution of TeSRE/CNR - Bologna and IAS/CNRS - Paris. Thanks also go to Jean-Claude Perrin, to Thomas Weigel and to Jacques Delabrouille for their contribution.

REFERENCES

1. CODE V reference manual - Version 8.30 - August 1998 - Optical Research Associates - Pasadena California.
2. ASAP reference manual - Version 6.0 - 1998 - Breault Research Organization - Tucson Arizona.
3. Technical description of GRASP8 - S-894-02-Knud Pontoppidan - TICRA.
4. PLANCK - Straylight evaluation of the carrier configuration - P. De Maagt, A. Martin Polegre and G. Crone.