

Micro and nano devices in passive millimetre wave imaging systems

R. Appleby*

The Institute of Electronics, Communications and Information Technology (ECIT), Queen's University Belfast, NI Science Park, Queen's Road, Queen's Island, Belfast, Northern Ireland, BT3 9DT.

ABSTRACT

The impact of micro and nano technology on millimetre wave imaging from the post war years to the present day is reviewed. In the 1950s whisker contacted diodes in mixers and vacuum tubes were used to realise both radiometers and radars but required considerable skill to realise the performance needed. Development of planar semiconductor devices such as Gunn and Schottky diodes revolutionised mixer performance and provided considerable improvement. The next major breakthrough was high frequency transistors based on gallium arsenide which were initially used at intermediate frequencies but later after further development at millimeter wave frequencies. More recently Monolithic Microwave Integrated circuits (MMICs) offer exceptional performance and the opportunity for innovative design in passive imaging systems. In the future the use of micro and nano technology will continue to drive system performance and we can expect to see integration of antennae, millimetre wave and sub millimetre wave circuits and signal processing.

Keywords: Millimetre wave imaging, diodes, detectors, mixers.

1. INTRODUCTION

Following the successful development and use of RADAR in projects such as Chain-Home¹ (1937) which provided early warning of aircraft approaching as they were crossing the English Channel, the use of Radio Frequency equipment was further investigated for passive and active imaging systems. It was reported² in 1955 that, "a radiometer coupled to a directional aerial forms an instrument which has many possible uses. Among these is the detection (from the air) of man-made objects by virtue of the microwave radiation which they emit or reflect, i.e. passive microwave detection". This early work explored the feasibility of passive millimetre wave imaging eventually resulting in an imager known as Green Minnow operating at 35 GHz. This instrument which is described in more detail in section 2 used mixers with whisker contact diodes and vacuum tubes for local oscillator and intermediate frequency amplifiers.

Since these early developments micro and nano semiconductor technology has produced many ground breaking devices. In this paper we review their development and the impact they had on system performance. The first major step was the introduction of Gunn and IMPATT diodes providing solid state sources for transmitters and local oscillators. Then whisker contacted diodes were replaced by planar diodes in mixers and gallium arsenide transistors provided wide bandwidth, low noise, compact intermediate frequency (IF) amplifiers. These enabled the build of instruments such as MITRE³, a 94 GHz passive imager, to demonstrate excellent image quality which is described further in section 3.

MITRE however was not real time, requiring tens of seconds to collect an image. To achieve real time imaging many parallel receivers were needed, coupled with an efficient scanning mechanism. This was achieved by using arrays of direct detection receivers that were constructed using monolithic microwave integrated circuits (MMICs) amplifying the millimetre wave radiation before detection. This also allowed the mixers and local oscillators to be dispensed with, leading to a much simpler architecture that could more easily accommodate a large number of receivers. Two imagers based on MMIC technology are described in section 4.

As an alternative to using semiconductor devices to amplify and detect the radiation, bolometers have been developed. Bolometers have much simpler architectures as they do not use amplification but they are also less sensitive. By cooling

* r.appleby@qub.ac.uk

the device and using large bandwidths this lack of sensitivity can be offset and demonstration systems have produced good imagery. An example of this technology is given in section 5.

All of the systems introduced so far use a quasi-optical method i.e. a lens or mirror to collect and focus radiation. This can also be achieved by aperture synthesis which constructs images by combining inputs from many small channels each consisting of an antenna and receiver. The phase and amplitude of each channel is combined using a beam former. This emerging technology is described in section 6 and we can anticipate increased integration as it matures. Finally a summary is given in Section 7.

2. VACUUM TUBES AND THE POST WAR YEARS

The Royal Radar Establishment at Malvern developed its first single channel millimetre wave airborne radiometers in 1955² and a schematic of its circuit is shown in Figure 1. The key components that enabled this system were the VX5023⁴ which was a reflex Klystron giving 30mW of power and the balanced mixer. The balanced mixer used VX3136 or VX3171 which were silicon crystals and these were contacted by a whisker as shown in Figure 2. This whisker system had been used successfully throughout the war but at lower frequencies. A plugin system⁵ was developed for airborne use as these devices often proved unreliable at high frequencies. The whisker was typically 100µm in diameter and the junction was formed at the contact with the silicon.

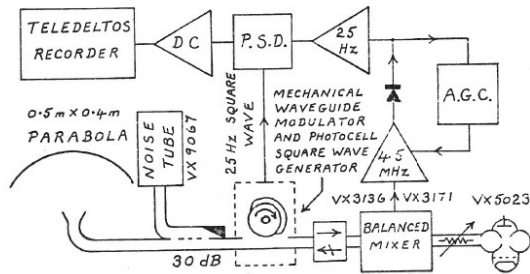

Figure 1 Single channel 8mm airborne radiometer made at RRE in 1955

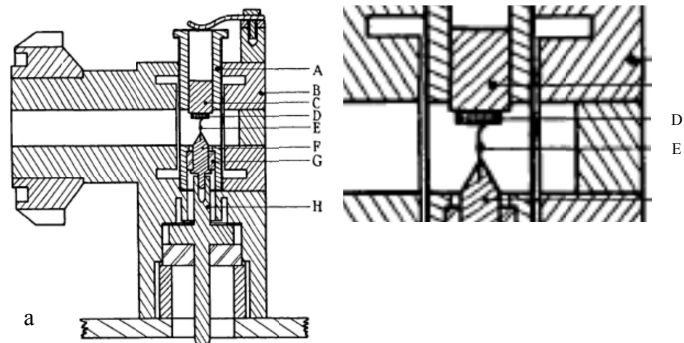
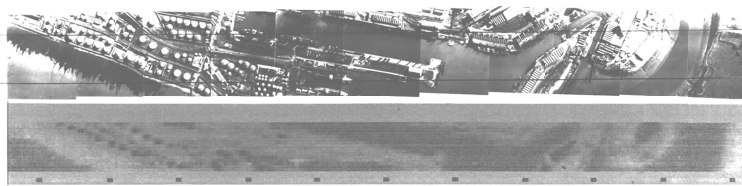
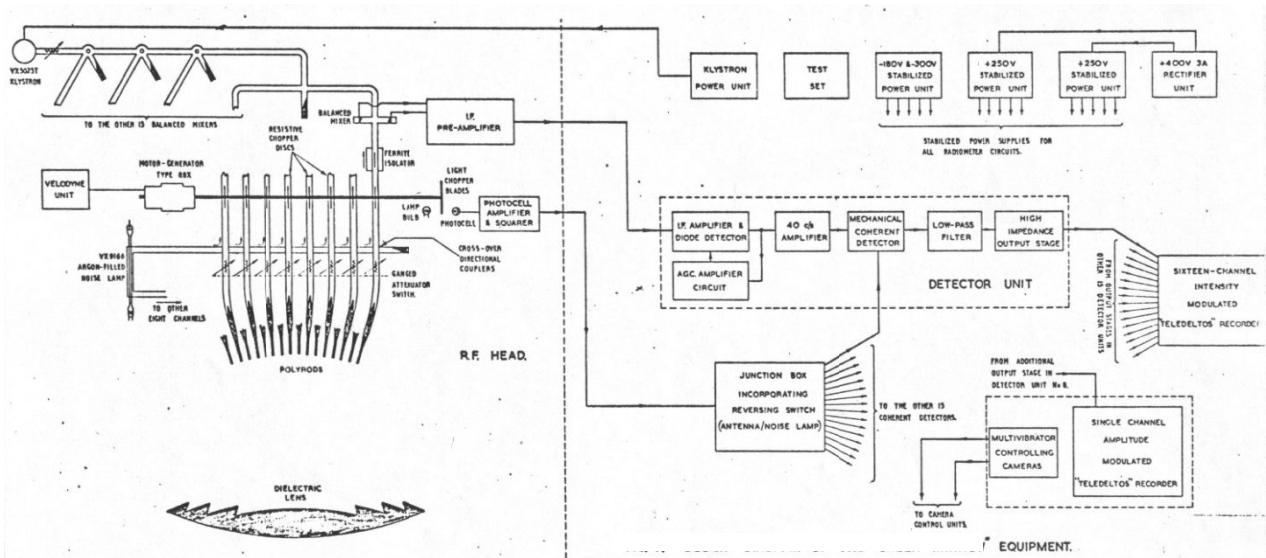

Figure 2 Plugin waveguide type of crystal and holder

A Metallic body, B Holder Body, C Metallic support, D Semiconductor, E Whisker, F whisker pin, G Ceramic Insulating bush, H Holder socket

This equipment, which was flown on a Lincoln bomber, had a fixed downward looking 0.5 m x 0.4 m parabolic aerial, a Dicke type radiometer operating at a wavelength of 8 mm and a single channel Teledeltos recorder. It received the 8 mm thermal radiation from a narrow strip along the ground. Temperature differences were detected between the sea, rivers, lakes, bridges, oil tanks, wet runways and metal buildings and overlaid with visible pictures confirming the origin of the signal. In the original report it was claimed that this was the world's first airborne radiometer.

Following this success, an imager, known as Green Minnow⁶, was developed. A simplified block diagram is shown in Figure 3a along with an image in Figure 3c. This equipment contained a 0.6 m diameter stepped polythene lens, 16 fixed polyrod feeds and 16 Dicke type 8 mm radiometers similar to the ones shown in Figure 2. These were independent from each other except for the fact that the 16 balanced mixers were all driven by a single local oscillator. A 16 line image of the ground below the aircraft was produced on a 16 channel intensity modulated Teledeltos recorder as shown in Figure 3c.



c

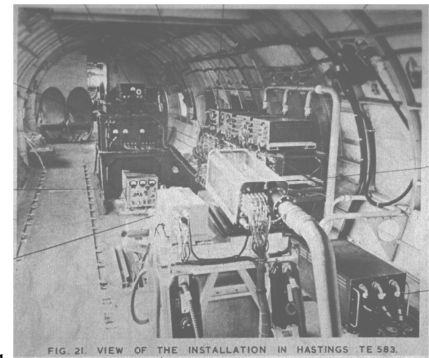

b

Figure 3 Green Minnow a. Block Diagram, b. Installation, c. Linescan Image

The Green Minnow imager is shown in Figure 3b installed in a Hastings aircraft. It contained 374 thermionic valves and weighed 500 kg. The intermediate frequency (IF) bandwidth was 10 MHz and the noise temperature of each channel was approximately 4500 K, including the input waveguide losses.

3. DISCRETE DEVICES

Research led to many novel semiconductor devices in the 1970s and 1980s. The ones which particularly impacted on imaging systems were the development of the Gunn diode, planar mixer diodes and solid state transistors operating at intermediate frequencies.

3.1 Gunn Diode

Gunn diodes based on gallium arsenide and silicon IMPATT diodes have been extensively used as sources for transmitters and local oscillators for mixers. Gunn diodes are transferred electron devices and under the correct DC biased conditions can produce output power of tens to hundreds of milliwatts up to a 100GHz. One recent example from e2Vⁱ is shown in Figure 4a with its associated composition based on nanometre dimensions in Figure 4b.

ⁱ <http://www.e2v.com/>

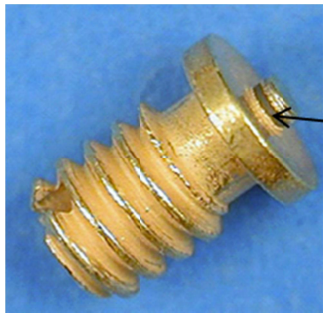

Gunn diode

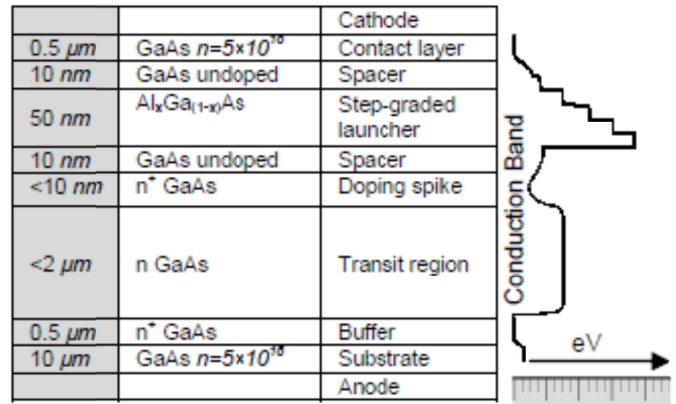

Figure 4b Layer structure⁷

Figure 4a Stepped Gunn Diode from e2V

3.2 Planar Mixer diode

The transition from whisker contact diodes to planar diodes constructed using a semiconductor process gave rise to devices which could operate at higher frequencies with improved performance. An example of a mixer diode pair from Virginia Diodesⁱⁱ is given in Figure 5. The whisker contact is replaced by the lithographically constructed junction that has dimensions of the order of a micron.

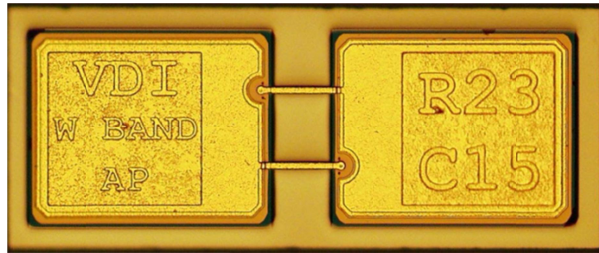

Figure 5 W band(94GHz) Mixer Diode anti parallel pair (600x250 μm)

3.3 Solid State Transistors

Solid state transistors as shown in Figure 6 with wide bandwidths, low noise figure and high gain enabled revolutionary instrument performance to be achieved when used in intermediate frequency amplifiers. Bandwidths of > 4GHz with associated noise figures of ~1dB and a gain per device of ~10dB were easily achieved.

ⁱⁱ <http://vadiodes.com>

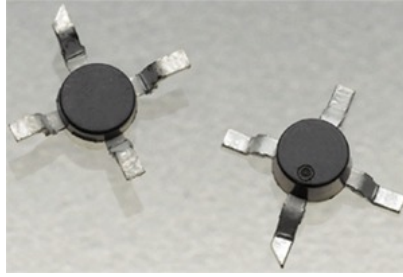

Figure 6 0.25 μm gate Low Noise pHEMT GaAs FETⁱⁱⁱ

One example of an imager using this technology was an 8 channel 94 GHz imager known as MITRE³. It had a 1.2 m square Cassegrain antenna mounted on azimuth and elevation gimbals, which were operated by DC servos under computer control. Each heterodyne radiometer had a noise temperature of about 600 K with an IF bandwidth of 2 GHz. The imager is shown in Figure 7a with an image in Figure 7b. MITRE established that passive millimetre wave imaging provided useful imagery for both surveillance and security and was able to penetrate obscurants. Its major limitation was its size, part of which was due to the gimbals and the fact that it took several seconds to produce an image.



Figure 7a. MITRE imager

b. 94 GHz Image of Severn Valley from the Malvern Hills UK.

The heterodyne approach has continued to be used at frequencies where direct amplification is not possible and systems have been developed at 250GHz⁸.

4. MONOLITHIC MICROWAVE INTEGRATED CIRCUITS

In the late 1980s the first monolithic microwave circuits began to appear based on gallium arsenide at 18-22GHz consisting of simple elements such as a mixer and amplifier. Over the next ten years with further refinement of the process it became possible to fabricate a direct detection receiver at 94GHz from one or two chips. This in turn made it possible to dispense with the mixer and local oscillator which had prevented the use of a large number of receivers. An early example of this was the 94GHz staring array camera produced by TRW⁹ (see Figure 8). In this device gallium arsenide MMICs with 0.1 μm gates were used to construct receivers. 40 receivers were mounted on a card and 26 cards were assembled into a focal plane. In total the camera had 1040 94GHz receivers with an 18" diameter plastic lens, updated at 17Hz and had a temperature sensitivity of 2K.

ⁱⁱⁱ <http://www.rfglobalnet.com/doc/SPF-2086T-01-12-GHz-Low-Noise-pHEMT-GaAs-FET-0002>



Figure 8a TRW Imager

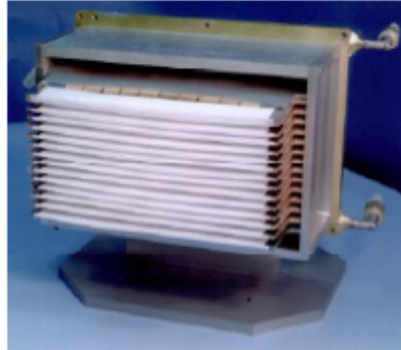

b Focal Plane showing 26 cards with 40 receivers

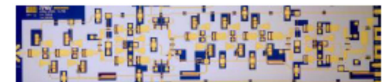

c MMIC chip GaAs 0.1µm HEMT

In a further development MMICs utilising indium phosphide pHEMT transistor technology were used to reduce the noise figure, and increase the gain and bandwidth of receivers at 94GHz¹⁰. These devices were used in the imager shown in Figure 9 which was developed for helicopter pilotage¹¹.

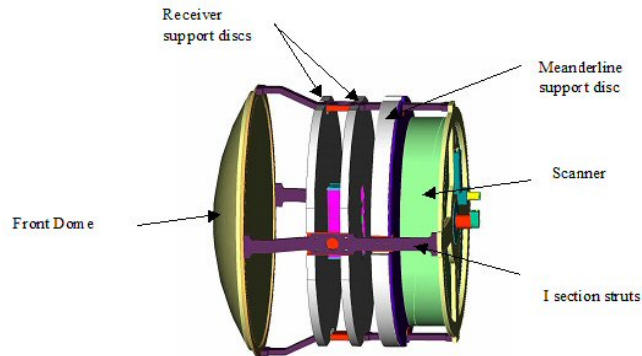

Figure 9 Helicopter imager

This imager is F/0.5, has a field-of-view 50° x 30° and is extremely well corrected optically. It uses 150 receivers to achieve ~1K thermal sensitivity whilst framing at 25 Hz. It has an aperture of 500 mm and a beamwidth of 7 mrad.

To maximise the sensitivity of the receivers it was necessary to operate over a wide bandwidth, e.g. 80 to 100 GHz, whilst maintaining a low noise figure. The direct detection receiver architecture consisted of a cascade of three low noise amplifiers, and a high sensitivity detector, followed by conventional dc electronics for noise voltage amplification. RF gain of approximately 50 dB was required to amplify the scene noise temperature above the noise floor of the detector. A receiver is shown in Figure 10 and consisted of an E-plane split waveguide block. The noise temperature was ~750 K. The receiver dimension was 46 (l) x 5 (w) x 4.5 (h) mm as it was necessary to minimise the height and width to ensure that they could be closely packed to sample the image effectively.

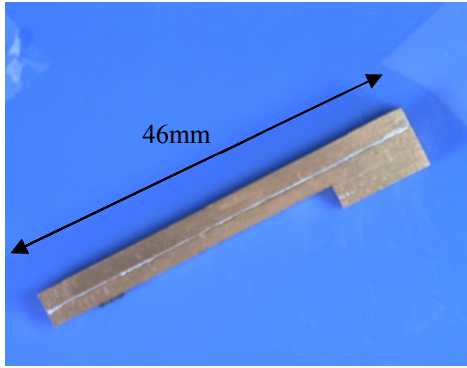
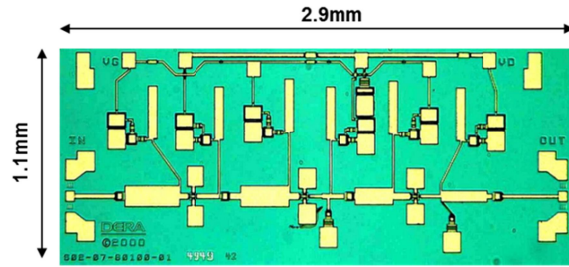

Figure 10a Direct Detection receiver



b Indium Phosphide MMIC 0.1µm HEMT

5. BOLOMETERS

Whilst many imagers have been developed based on semiconductor devices others have used bolometers. This greatly simplifies the architecture but in general is less sensitive. Sensitivity can be improved by cooling the device and it is a natural extension to use a superconducting material. Figure 12a shows an imager complete with a cryostat capable of working from 0.2-1THz. The detector which is a Niobium Nitride (NbN) superconducting bolometer¹² has been used to build an array of 128 elements. Here the bolometer is of the order of 10 µm in size and the spiral antenna is used to couple extremely wide bandwidth radiation into the device.



Figure 11 Imager using NbN bolometers a THz imager

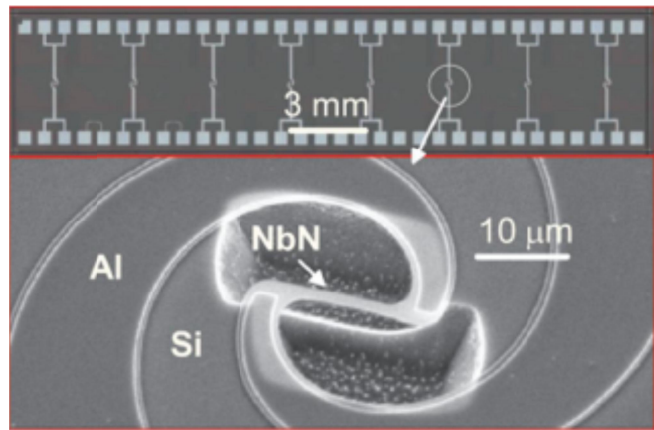

b NbN Superconducting antenna coupled hot spot microbolometer

6. SYNTHETIC APERTURES

Systems operating in other wavebands have used micro and nano technology to manipulate the radiation at the wavelength scale and this is what drives the scale of the devices. In the millimeter waveband where the wavelength is 10-1mm this is not the case. It should also be noted that in this waveband, systems which manipulate incoming radiation by either analogue or digital means to produce images have been around for many years in the form of aperture synthesis instruments. This technique, originally used by radio astronomers¹³, combines several small telescopes into a large array to produce an image with a spatial resolution defined by the dimensions of the large array.

More recently this technique has been applied to millimeter wave imaging¹⁴ and imaging demonstrations have produced promising results¹⁵.

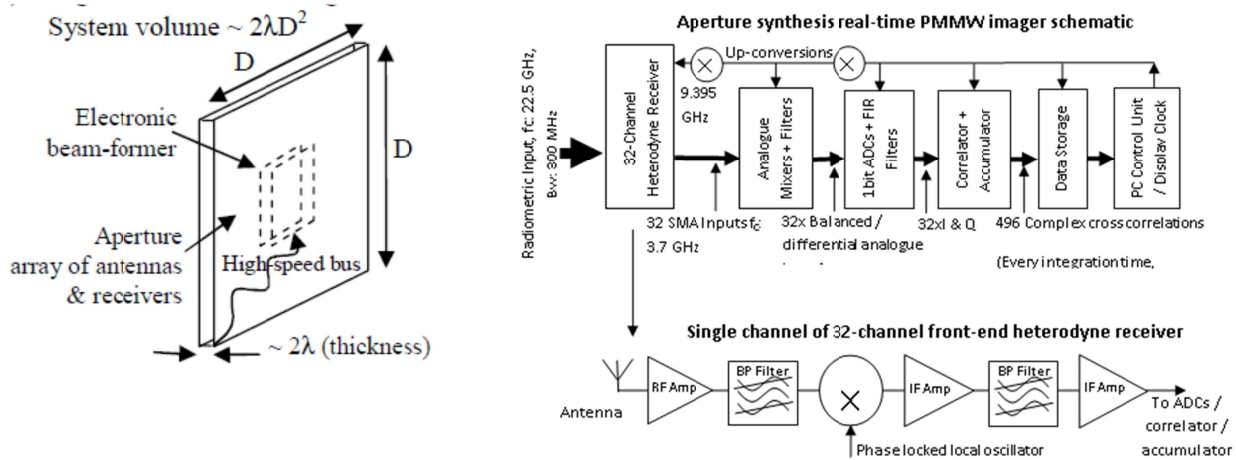

Figure 12 Aperture synthesis Imaging a Flat panel Imager using digital beam forming – Aperture is divided into 32 sub apertures

b Circuit diagram top: Imager, bottom: Receiver channel

In this system the incoming radiation is mixed down to an intermediate frequency where both phase and amplitude can be digitized and the beam forming is performed digitally in a computer. It is necessary to mix down at this time as digitization cannot be conducted at the frequencies used for millimeter wave imaging and gain is necessary to achieve adequate signal to noise.

These instruments are manipulating the radiation at a sub wavelength scale but the use of micro and nano technology is limited to the discrete components identified in section 3. It is however likely that MMICS as described in section 4 will be incorporated as the technology matures.

7. SUMMARY

In the fifty years since Green Minnow there have been many changes in imaging systems. Perhaps the greatest impact is from gallium arsenide and indium phosphide MMICs operating at 35 and 94 GHz. These devices have sub-micron gate lengths and have given rise to compact low noise receivers with excellent temperature sensitivity. The temperature sensitivity of the MMIC based systems has improved by approximately 50 times when compared to Green Minnow assuming the same integration time. This is a result of an increase in bandwidth from the 10 MHz (Green Minnow) to 20 GHz (helicopter imager) and the noise temperature of the receivers has also been reduced from 4500 to 750 K.

In the next fifty years we can anticipate very high speed digital processors and highly sensitive receivers resulting from improvements in semiconductor devices. This will almost certainly give rise to systems where the mechanical scan is replaced by an electronic system and the beam forming is done electronically. It is also highly likely that we will continue to see more and more functions integrated together not just at the electronic level with analogue and digital circuits but at the functional level with more active components being closely integrated with the antenna.

REFERENCES

- [1] Tomlin, D. H., "The RSRE a brief history from earlier times to present day," IEE Review, 403-407 (1988).
- [2] C. R. Ditchfield and T. S. England, "Passive detection at Q band," RRE Memorandum, 1124, (1955).
- [3] Gleed D. G., Appleby R., Salmon N. A., Price S., Sinclair G. N., Anderton R. N., Borrill J. R., Wasley M. R. M., and Lettington A. H., "Operational issues for passive millimetre-wave imaging systems," *Proceedings of SPIE* 3064, 23-33 (1997).

- [4] Wootten, D. J. and Pearce, A. F., "A reflex klystron oscillator for the 8-9 mm band," *Proc. IEE B: Radio and Electronic Engineering*, 102(6), 858-860 (1955).
- [5] Ditchfield, C. R., "Crystal-mixer design at frequencies from 20,000 to 60,000 Mc/s," *Proceedings of the IEE - Part III: Radio and Communication Engineering*, 100(68), 365-371 (1953).
- [6] R. M. Garnham and N. T. W. Graham, "Flight trials with the Green Minnow equipment," *RRE Memorandum*, 1461, (1958).
- [7] Amir F., Farrington N., Tauqeer T., and Missous M., "Physical modelling of a step-graded AlGaAs/GaAs Gunn Diode and investigation of hot electron injector performance," *Advanced Semiconductor Devices and Microsystems* (2008).
- [8] Mann C., "First demonstration of a vehicle mounted 250GHz real time passive imager," 7311, (2009).
- [9] L. Yujiri, M. Shoucri, and P. Mofa, "Passive Millimetre Wave imaging," *IEEE Microwave Magazine*, 2003, pp. 39-50.
- [10] Alexander N., Callejero C., Fiore F., Gomez I., Gonzalo R., de Luna A. E., Ederra I., and Palacios I., "Suicide bomber detection," *Proceedings of SPIE 7309*, 73090D (2009).
- [11] Appleby R., Anderton R. N., Price S., Salmon N. A., Sinclair G. N., Coward P. R., Barnes A. R., Munday P., Moore M. T., Lettington A. H., and Robertson D. A., "Mechanically scanned real-time passive millimetre-wave imaging at 94 GHz," *Proceedings of SPIE 5077*, 1-6 (2003).
- [12] Luukanen, A. and Pekola, J. P., "A superconducting antenna-coupled hot-spot microbolometer," *Applied Physics Letters*, 82(22), 3970-3972 (2003).
- [13] Wilson, T. L., Rohlf, K., and Huttemeister, S., *Tools of Radio Astronomy*. Springer, Berlin, (2009).
- [14] Salmon N. A., Beale J., Parkinson J., Hayward S., Hall P., Macpherson R., Lewis R., and Harvey A., "Passive millimetre wave digital beam-forming security imaging," *Proceedings of SPIE 6739*, 67390S (2007).
- [15] Salmon N. A., Wilkinson P., and Taylor C., "Interferometric aperture synthesis for next generation passive millimetre wave imagers," *Proceedings of SPIE 8544*, 854405 (2012).